

6-5 Transversals & Parallel Lines (ver3)\_hw

Solve for  $x$ .

1)

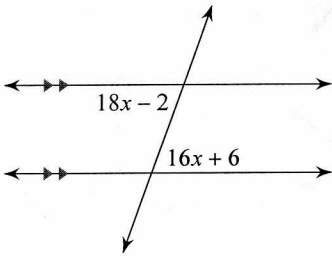

2)

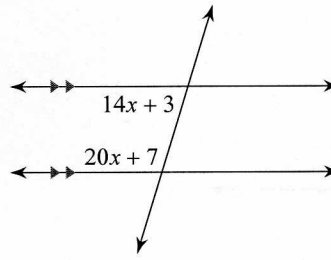

3)

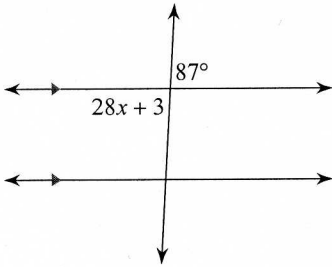

4)

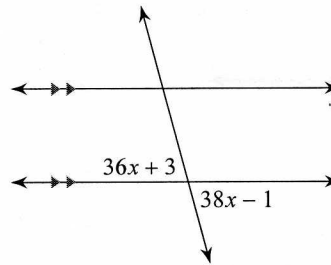

5)

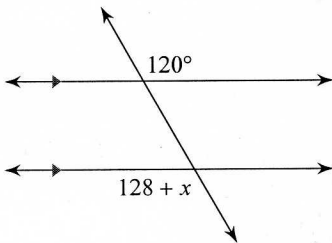

6)

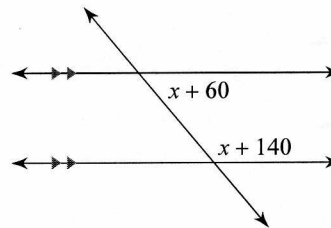

7)

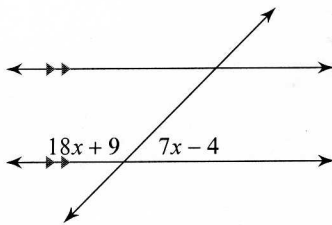

8)

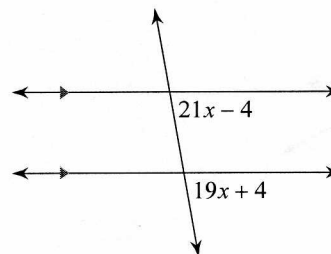

9)

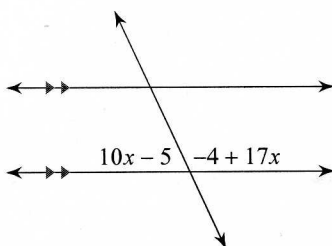

10)

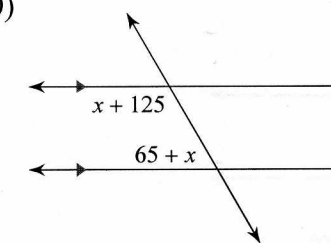

11)

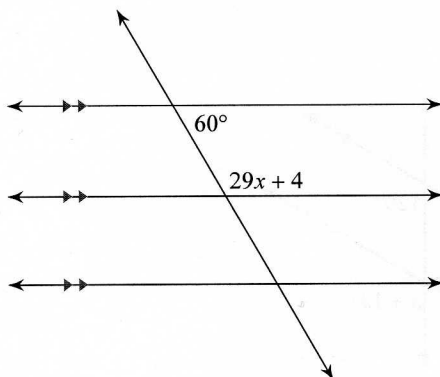

12)

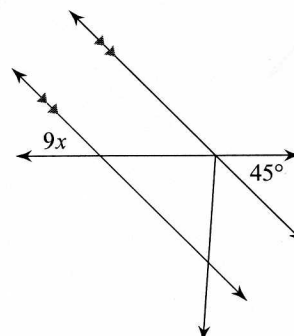

13)

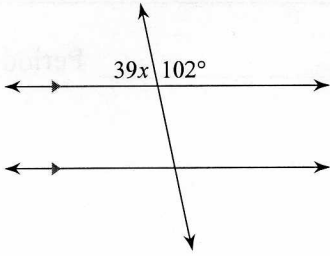

14)

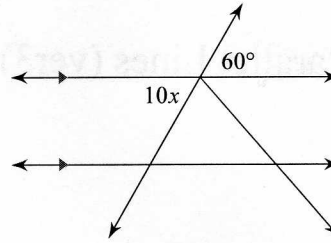

15)

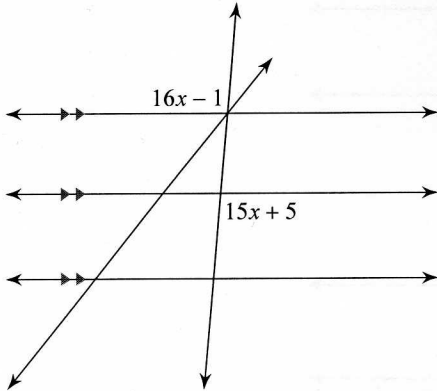

16)

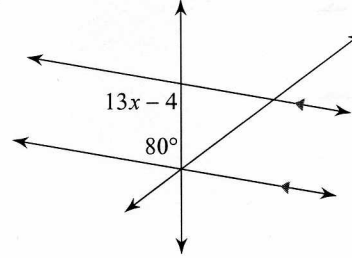

17)

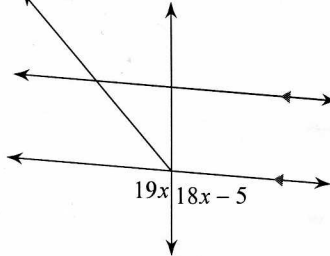

18)

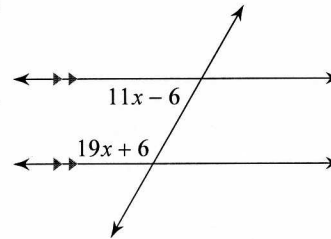

19)

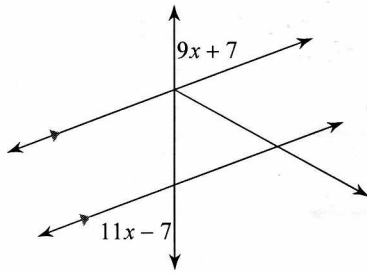

20)

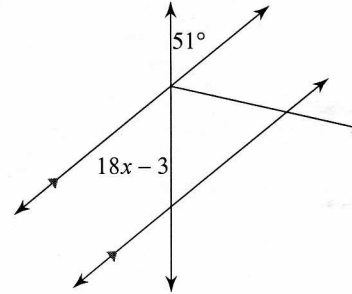

21)

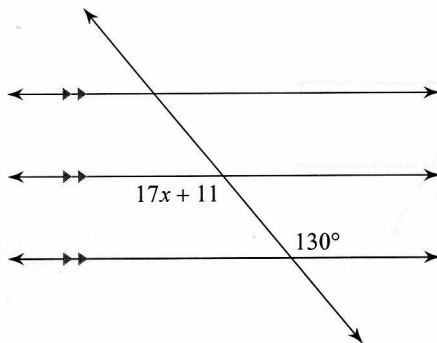

22)

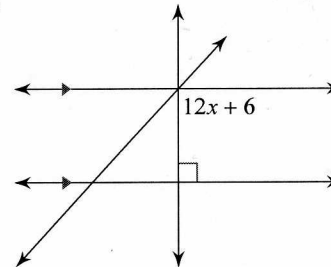

23)

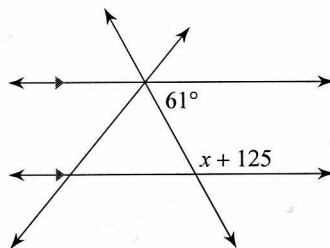

24)

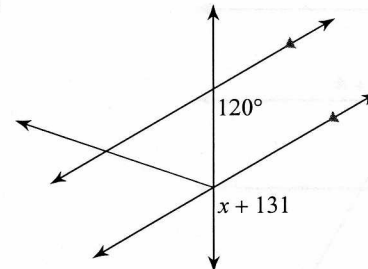

Answers to 6-5 Transversals & Parallel Lines (ver3)\_hw

- 1) 4
- 2) 5
- 3) 3
- 4) 2
- 5) -8
- 6) -10
- 7) 7
- 8) 4
- 9) 7
- 10) -5
- 11) 4
- 12) 5
- 13) 2
- 14) 6
- 15) 6
- 16) 8
- 17) 5
- 18) 6
- 19) 7
- 20) 3
- 21) 7
- 22) 7
- 23) -6
- 24) -11